

aCapella VERSE - Baffles

Top Clamp - Ceiling Installation (up to 48" Long)

APPLICATION:

For ceiling mounting aCapella Verse Baffles up to 48" long, using a Top Clamp.

TOOLS NEEDED:

Drill, 5/16" Spade Drill Bit, (1) Slotted Screwdriver

MOUNTING HARDWARE:

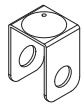

Top Clamp



Threaded Through Bolt (TTB)

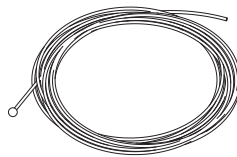

10' Cable with Swage

INSTALLATION INSTRUCTIONS:

1. Each Verse Baffle requires two (2) Top Clamps. Measure 6" from the top corner and mark.
2. Align one edge or center of the Top Clamp on the 6" mark then locate the holes on the side of the Top Clamp and mark the Verse Baffles through the holes. Mark location of center Top Clamp if required.
3. Remove the Top Clamp and drill one (1) 5/16" hole. Repeat on the opposite top corner, and center for all remaining Verse Baffles.
4. Insert the cable up through the top hole in each Top Clamp. Pull cable through Top Clamp until the swage sits snug inside Top Clamp.

Step 1

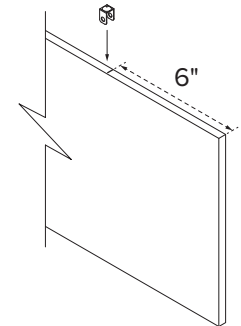

Step 2

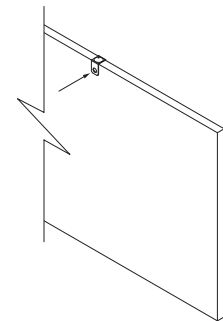

Step 3

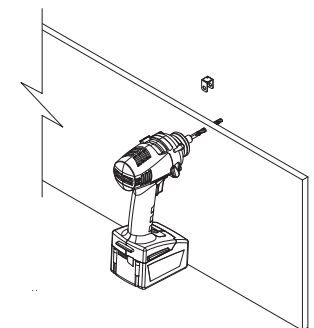

Step 4

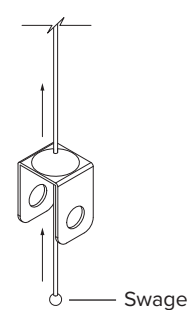

aCapella VERSE - Baffles

Top Clamp - Ceiling Installation (up to 48" Long)

- Slide Top Clamp onto Verse Baffles, aligning Top Clamp hole with 5/16" pre-drilled holes in baffles. Attach using the Threaded Through Bolts. **Ensure all Verse Baffles' fronts are facing the same direction.** Hand tighten with slotted screwdriver. Repeat for all.

The Verse Baffle is now ready to hang. Use appropriate fasteners and hardware to install the baffles from the structure. All cables from Verse baffle must be hung plumb and all mounting points in-line, failure to do so can cause baffle to curve or bend. Remove all stickers before hanging.

HANDLING AND STORAGE

aCapella panels must be stored indoors in a dry, climate controlled environment at all times. Exposure to moisture, excessive heat or humidity can cause panels to warp and/or stain.

Panels should be stored in a flat, fully supported, horizontal position and NOT on edge. It is recommended that 2 people carry each panel. Panel should be carried on edge, being careful not to bend panel at any time. Clean white gloves are also recommended when handling aCapella panels.

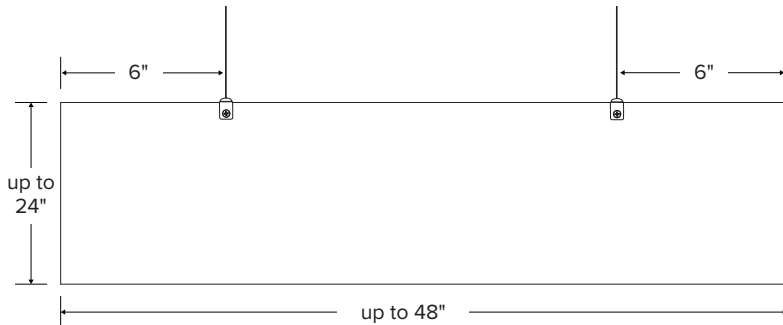

Step 5

